

BS-6045 Research Inverted Metallurgical Microscope



BS-6045



Front



Left side

Introduction

BS-6045 research inverted metallurgical microscope has been developed for research with a number of pioneering designs in appearance and functions, with wide field of view, high definition and bright&dark field semi-apochromatic and apochromatic metallurgical objectives and ergonomical operating system, it could provide a perfect research solution.

Features

1. Excellent Infinite Optical System.

With the excellent infinite optical system, semi-APO and APO objectives, BS-6045 Inverted metallurgical microscope provides high resolution, high definition and chromatic aberration corrected images.

2. 3-layers Mechanical Stage.

3 layers mechanical stage 340x230mm, moving range 130x85mm, Maximum support 30kgs. The spacious workspace for large and heavy samples. Anti-scratching stage surface, suitable for observation of various materials and shapes specimens. At the same time, there are many kinds of specimen plates, it can observe and analyze all kinds of small specimens. The flexible low-position knob is accurate and comfortable when moving sample.



3. Clear Imaging, Reliable result.



(1) NIS45 Semi-APO and APO Objectives.

The NIS45 Infinite LWD Plan BF&DF 5×, 10×, 20× Semi-APO and 50×, 100× APO objective lens can reproduce the natural color accurately by using carefully selected high-transparent glass and advanced coating techniques.

(2) 3 Camera Interface Available.

Camera adapters can be connected on trinocular head and at both sides. Used to connect camera and various application extension accessories. By means of a light splitting lever, to realize splitting ratio of different optical paths. At the same time, it can be equipped with 0.4x, 0.5x, 1x C-mount adapters and difference cameras to meet different image requirements.



(3) Internal Magnification Changeover.

With built-in turret magnification changeover structure, 1X and 1.5X magnification can be changed accordingly. Provide higher magnification and more details of the specimens.

(4) Kohler Illumination.

Kohler Illumination is regarded as the perfect illumination system for microscopes, which provides perfect bright and uniform field of view, and makes it possible to expand the functions of microscope at the same time.

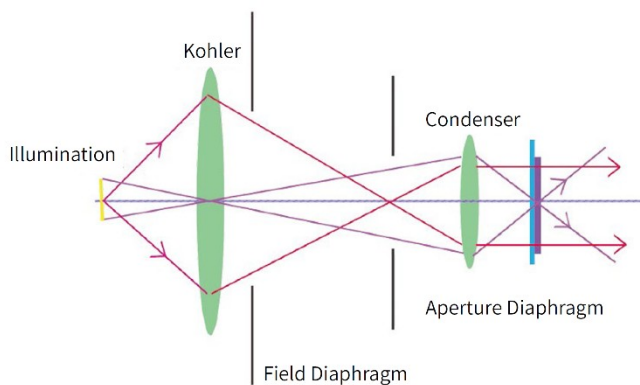

4. High flexibility, offer more possibilities.

(1) Various Sliders for High Quality Image.

Field diaphragm and iris diaphragm can be used to adjust the field of view and the sharpness of the imaging, also adjust aberration. The iris diaphragm and filter can easily adjust the brightness or color of light. The analyzer slider can adjust the polarizing observation and DIC image. Multiple sliders are used in combination to ensure high quality images.



(2) Six-Position Observation Module Turntable Structure.

It adopts a six-position observation module turntable structure, the observation modules can be easily taken out from the turntable and convenient to place each kind of observation module. When using, just turn the dial to change observation mode, accurate positioning and easy to use.

5. Ergonomic Design, Comfortable Operation.



(1) Low-position Control Knobs.

Coaxial focusing system with low-position X-Y coaxial control knobs, so the head can be placed on the table. The ergonomic design provides operators comfortable experience.



(2) 45° Inclined Viewing Head.

No matter standing or sitting, users can observe in a natural posture, which reduce fatigue. The interpupillary distance and Diopter of the eyepiece can be adjusted to user's requirement.

6. Various Observation Methods.

With the development of scientific research, single observation mode is not enough for complex scientific research and testing requirement. BS-6045 can achieve multiple observation requirements, regardless of Bright Field, Dark Field, DIC, Polarizing and Fluorescent observation, all can get clear, high definition and complete image.

Observation Mode	Bright Field	Dark Field	DIC(optional)	Fluorescent(optional)	Polarizing
BS-6045	√	√	√	√	√

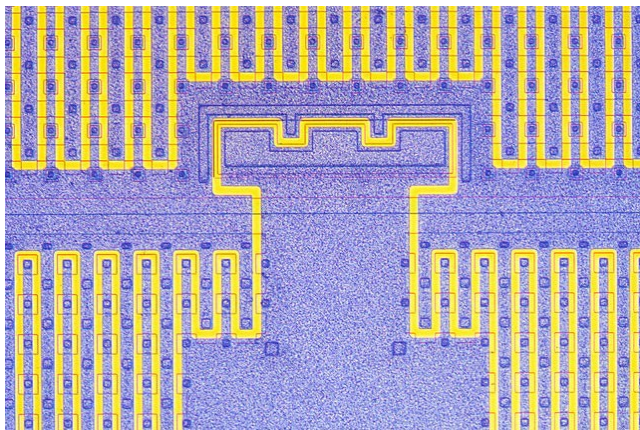

Electronic chip, Reflection, Bright field

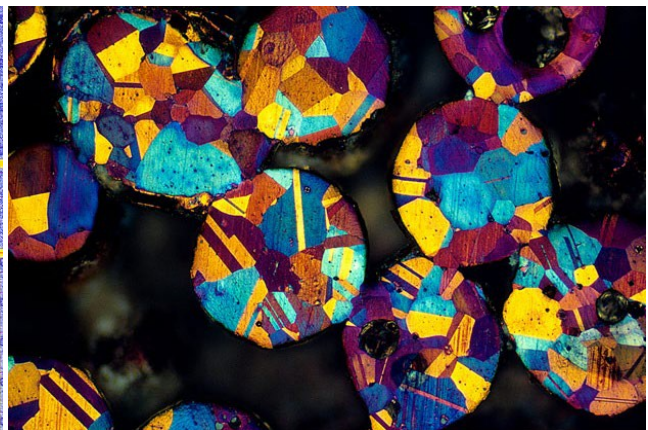

Bronze powder, Reflection, Polarizing

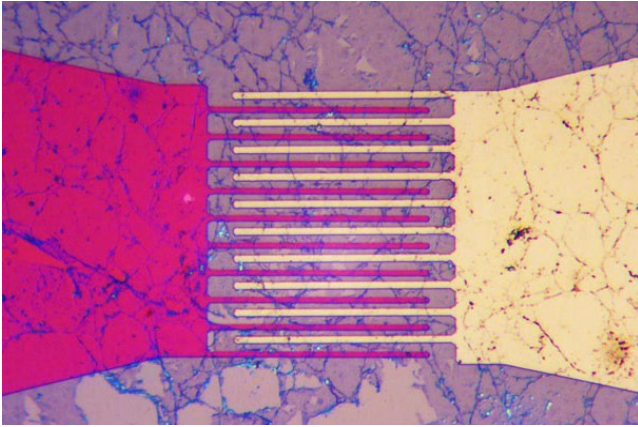

Electrode, Reflection, Bright field



High chromium nickel alloy, Reflection, Polarizing

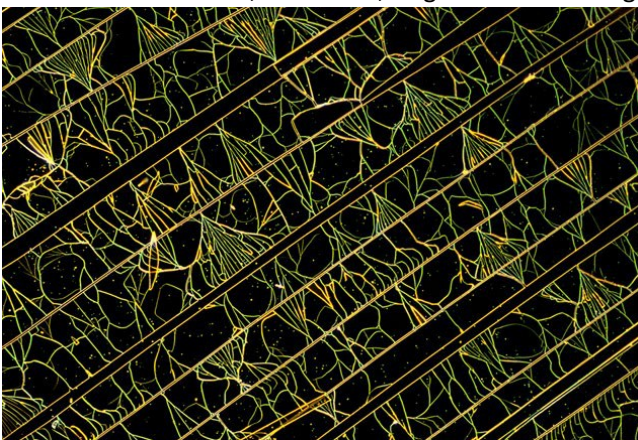

Embossing of silicon nitride, Reflection, Dark field

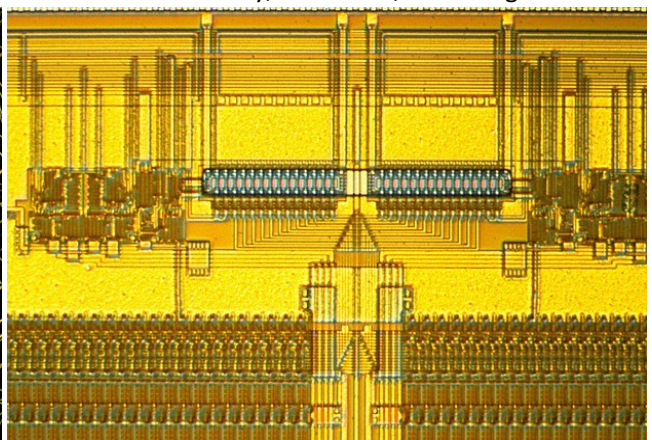

Integrated circuit, Reflection, DIC

Application

BS-6045 research inverted metallurgical microscope is widely used in institutes and laboratories to observe and identify the structure of various metal and alloy, it also can be used in electronics, chemical and semiconductor industry, such as wafer, ceramics, integrated circuits, electronic chips, printed circuit boards, LCD panels, film, powder, toner, wire, fibers, plated coatings, other non-metallic materials and so on.

Specification

Item	Specification	BS-6045
Optical System	NIS45 Infinite Color Corrected Optical System (Tube length: 200mm)	●
Viewing Head	Siedentopf Trinocular Head, inclined at 45°, interpupillary distance 47mm-78mm; 3 position beam split ratio: 50/50, 100/0, 0/100	●
Eyepiece	Super wide field plan eyepiece SW10×/22mm, diopter adjustable	●
	Super wide field plan eyepiece SW10×/25mm, diopter adjustable	○
	Wide field plan eyepiece WF15×/16mm, diopter adjustable	○
	Wide field plan eyepiece WF20×/12mm, diopter adjustable	○
Objective	NIS45 Infinite LWD Plan Semi- 5×/NA=0.15, WD=20mm	●

	APO Objective (BF & DF)	10×/NA=0.3, WD=11mm	●
		20×/NA=0.45, WD=3.0mm	●
	NIS45 Infinite LWD Plan APO Objective (BF & DF)	50×/NA=0.8, WD=1.0mm	●
		100×/NA=0.9, WD=1.0mm	●
Nosepiece	Sextuple Nosepiece (with DIC slot)		●
Reflected Illumination	Reflected light 12W/100W halogen lamp, Koehler illumination, with 6 position turrets		●
	BF1 bright field module (has function of reducing the light intensity and anti-glare)		○
	BF2 bright field module		●
	DF dark field module		●
	Color correction yellow, green filter, Built-in blue filter		●
	Built-in ND6, ND25 filter and color correction filter		○
	Four-band fluorescent module		○
	100W HBO Lamp		○
Focusing	Low-position coaxial coarse and fine focusing, fine division 2μm, Moving range 9mm		●
Stage	Three-layer mechanical stage, stage size: 340×230mm, movement range 130×85mm, flexible knob. Different size small stages could be attached to main stage		●
Auxiliary Stage	Φ20 Field aperture, Φ28 Field aperture, Drop-shaped field aperture		●
Internal magnification	1×, 1.5×		●
Image Output	Output changeable (Left side / Right side / Eyepiece tube) Splitting ratio: Left / Eyepiece =100/0; Right / Eyepiece =80/20; Left(or Right) / Eyepiece =0/100		●
DIC Kit	DIC 5×-20× (can be used for 5×, 10×, 20× objectives)		○
	DIC 50×-100× (can be used for 50×, 100× objectives)		○
Polarizing Kit	Polarizer for reflected illumination		●
	Analyzer for reflected illumination, 0-360° rotatable		●
Other Accessories	0.4× C-mount Adapter		○
	0.5× C-mount Adapter		○
	1× C-mount Adapter		●
	Dust Cover		●
	Power Cord		●
	Calibration slide 0.01mm		○
	Specimen Presser		○

Note: ● Standard Outfit, ○ Optional

Dimension

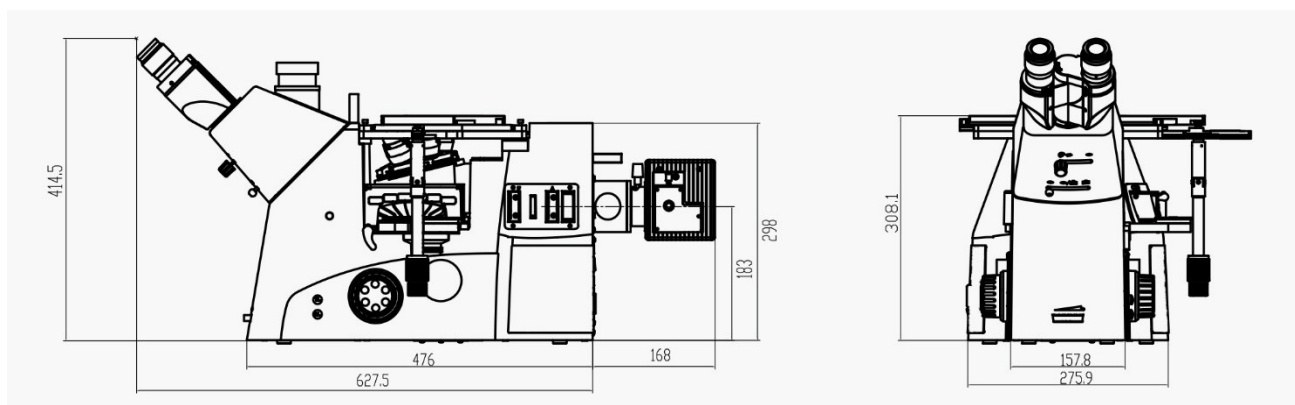

Unit: mm

System Diagram

